

# DV96 Adroit (Integral CO<sub>2</sub> Sensor)

Adroit Line Top Entry -  
Up to 320 m<sup>3</sup>/h air volume @100Pa



## KEY FEATURES

- For use in dwellings up to 130 m<sup>2</sup> \*
- Up to 90% thermal efficiency and low SFP
- 'A' energy rating
- Internet control by smart phone, tablet or PC
- Triple filter design with two ISO Coarse > 75% (G4) and one ISO ePM1 50% (F7) filters - ISO 16890 compliant
- Automatic, 100% summer by-pass
- Integral humidity and carbon dioxide sensors
- Galvanised steel, double-skin casing
- BMS (Modbus / KNX) connection
- Optional LCD digital controller with four independent environmental profiles
- Optional manual four speed controller
- Auto cut-out switch for extra safety
- Optional built-in Electric Post-heater
- Optional smart frost protection
- Complies with Building Regulations and Passive House certified
- 5 year warranty+

## DV96 Adroit (Integral CO<sub>2</sub> Sensor)

With its powerful air volume capacity and high thermal efficiency the DV96 Adroit is suitable for medium sized family homes. Control your indoor air environment at home or on the go via the Adroit 'Cloud' internet control by smart phone, tablet or PC.

With the triple filter design with an ISO ePM1 50% (F7) pollen filter, the DV96 Adroit provides additional protection against invisible, harmful particles and creates an ultra hygienic environment.

The automatic, 100% summer by-pass facility isolates the heat recovery function and helps to effectively maintain a temperate indoor air climate during the summer months.

The unit includes an easily removable, plastic heat exchanger and may be equipped with a range of optional accessories for higher performance.



## TECHNICAL DATA

Specification	DV96
Suitable for dwellings up to m <sup>2</sup>	130
Max air flow (m <sup>3</sup> /h) / (l/s) at 100Pa.	320 / 89
Thermal efficiency (%)	Up to 90
Heat exchanger	Cross-Counter-Flow (Plastic)
Fans	EC
Summer by-pass damper	100% automatic
Integral humidity sensor (RH %)	0 - 100
Frost protection (optional)	Smart Frost
Controls (optional)	Digital - 4 Profiles, 100% adjustable Manual - 4 Speed controller, adjustable
Connection to BMS	Modbus / KNX optional
Mounting	Wall / Ceiling
Sound power level @3m (dB(A))	48
Duct diameter (mm)	125 (4 ports)
Condensate discharge (ins)	3/4 BSP
Electrical supply	230V / 1ph / 50Hz
Max. power consumption (W)	162
Filter Class*	2x ISO Coarse > 75% (G4) and 1x ISO ePM1 50% (F7)
Built-in electric post-heater (optional) (W)	900
Protection class	IP34
Casing insulation (mm)	20
Weight (kg)	53
Dimensions (L x D x H) (mm)	600 x 430 x 545
Duct entry	Top Entry
Versions available	
Right Hand:	90001265
With optional electric post-heater:	90001265EPH
Left Hand:	90001266
With optional electric post-heater:	90001266EPH

\*Complies with ISO 16890

## DIMENSIONS

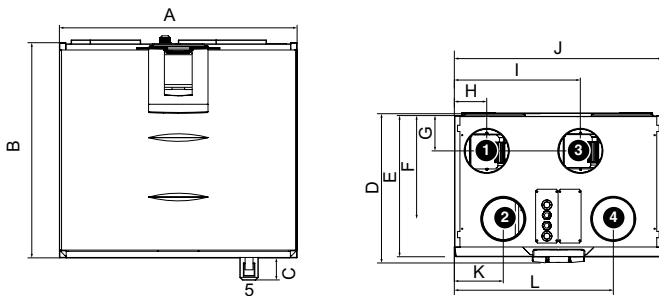

### Duct outlets, model R

Inner diameter of female outlet collar ø 125 mm

1. Supply air to dwelling
2. Extract air from dwelling to unit
3. Exhaust air out
4. Outdoor air to unit
5. Condensate drain

### Duct outlets, model L

Inner diameter of female outlet collar ø125mm

1. Exhaust air out
2. Outdoor air to unit
3. Supply air to dwelling
4. Extract air from dwelling to unit
5. Condensate drain

+ excludes motors. Motor warranty one year from date of purchase

Model	A	B	C	D	E	F	G	H	I	J	K	L
DV96	600	545	55	430	407	298	102	93	363	600	141	459

## PERFORMANCE

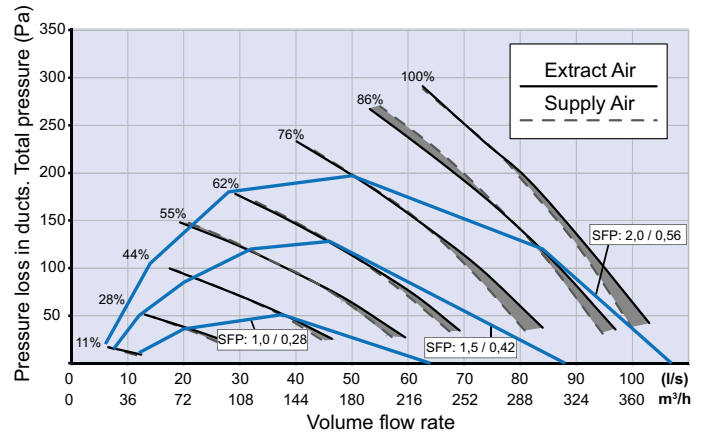

\* Guidance only. Dependant upon system pressure.

## ACCESSORIES

### Adroit Digital Controller

Wall mounted, LCD display with four 100% independently user adjustable air flow profiles (Home, Away, Boost, Custom). A range of indoor parameters ie: air flow rates, temperature, humidity, by-pass, time clock settings, CO<sub>2</sub> sensor, filter alert are adjustable to suit your indoor environment. Internet connectivity via Adroit 'Cloud' for control at home or on the go.

### Adroit Speed Controller

Wall mounted, four speed (independently adjustable) rotary switch air flow controller.

Visit [airflow.com](http://airflow.com) for Adroit controls options data sheet.

Accessory	Product Code
Adroit Digital Controller	90000610
Adroit Relative Humidity Transmitter	90000612
Adroit CO <sub>2</sub> Transmitter	90000613
Adroit Speed Controller	9041219
Ceiling Mounting Plate	90000716
Attic Roof Penetration Plate	90000718
Additional 900W Heater for DV96 (R)	90000614
Additional 900W Heater for DV96 (L)	90000615
Filter set (ISO Coarse > 75 % + ISO ePM, 50%, ISO Coarse > 75 %) (2xG4, 1xF7)	90000375
Boost Switch	90000542
KNX-Converter	90000723

## CERTIFICATION

The DV96 Adroit meets requirements set out by the Energy Related Products (ErP) Directive 2016, achieving an A rating. You can find out more about the ErP Directive at: [www.airflow.com](http://www.airflow.com)

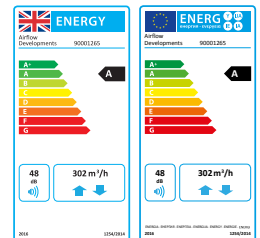

The DV96 was tested and has achieved Passive House Approval by the Passive House Institute when equipped with the optional Electric Post-heater.



# DV96 Adroit (Integral CO<sub>2</sub> Sensor)

Adroit Line Top Entry -  
Up to 320 m<sup>3</sup>/h air volume @100Pa

The DV96 Adroit is fitted with a unique triple air filter facility. It comes with two ISO Coarse > 75% (G4) air filters and an ISO ePM1 50% (F7) filter, which provides additional air filtration by prevent particles as small as pollen from entering the premises. This is of particular benefit to those that suffer from asthma or hay fever and other respiratory conditions.

You can control your Adroit unit via internet or local network using laptop, smartphone, tablet etc. As an option there is a digital controller available that enables you to adjust the ventilation levels of your Adroit unit as well as setting the user profiles. The controller provides significant information to the user regarding the performance of their Adroit system including; adjusting the ventilation levels, filter maintenance, separate fan control, faults in the system and commissioning

the system. You can also use an optional manual controller which provides simple control by switching ventilation profiles.

Through combining your unit with additional humidity and CO<sub>2</sub> sensors, you are able to achieve on-demand ventilation for the property. This is possible, as due to changes to humidity and CO<sub>2</sub> levels that occur through changes in occupancy or usage, the ventilation will boost or reduce to match demand; without the need of manual intervention.

The DV96 can be integrated with a Building Management System (BMS) via a Modbus connection or KNX, which allows the user to monitor and control the unit's functions via a central control system.

## NEW SMART FROST PROTECTION

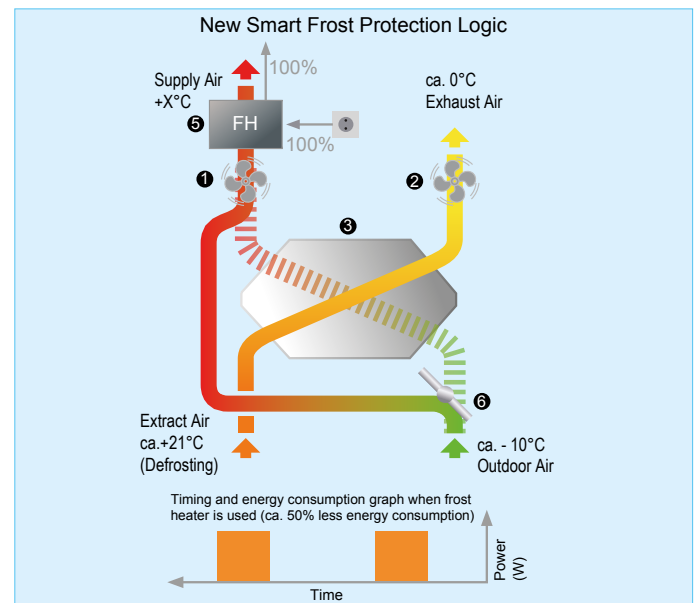
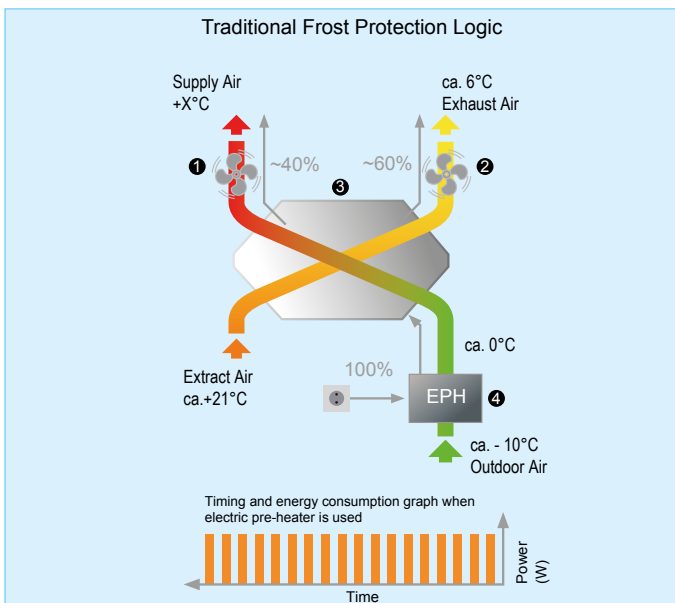

On the traditional frost protection method, the outdoor air is pre-heated before passing through the heat exchanger. This way the unit could still provide balanced ventilation even when the frost protection was on. However, the electric heater kicks in intermittently hence consumes more energy than needed.

The new Smart Frost Protection method works in a more energy efficient manner which constantly monitors the heat exchanger conditions and uses the frost heater only when necessary. This significantly reduces the energy consumption and provides more heat recovery throughout the winter season.

- ① Supply air fan
- ② Exhaust air fan
- ③ Heat exchanger
- ④ Electric pre-heater
- ⑤ Frost heater
- ⑥ Electric bypass damper



## TRIPLE FILTER DESIGN

The majority of the MVHR units in the U.K incorporate ISO Coarse > 75% (G4) filters on the extract / supply air side. These filters catch only coarse particles such as insects and leaves to protect the heat exchanger.

ISO ePM1 50% (F7) fine filters on the other hand are highly efficient, catch invisible particles such as pollen, spore, bacterium and **dust entering the lungs**.

**Adroit units are the only MVHR units which incorporate triple filter design combining ISO Coarse > 75% (G4) course filters with the ISO ePM1 50% (F7) fine filter. This significantly improves the indoor air quality and lowers your maintenance costs.**



ISO Coarse > 75% (G4) filter

ISO ePM1 50% (F7) filter

## 100% AUTOMATIC BYPASS

The unit is equipped with an automatic, 100% bypass which totally isolates the heat exchanger so that no air passes through it. This prevents overheating the dwelling in the summer season.

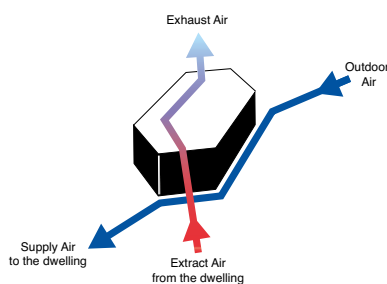

## SAP RESULTS

Systems with rigid ductwork only SAP 2009 results

Exhaust terminal configuration	Specific Fan Power (W/l/s)	Thermal efficiency (%)
Kitchen+1 additional wet room	0.95	89%
Kitchen+2 additional wet rooms	0.85	89%
Kitchen+3 additional wet rooms	0.89	88%
Kitchen+4 additional wet rooms	1.01	87%
Kitchen+5 additional wet rooms	1.16	87%
Kitchen+6 additional wet rooms	1.33	86%

Systems with rigid ductwork only SAP 2012 results

Exhaust terminal configuration	Specific Fan Power (W/l/s)	Thermal efficiency (%)
Kitchen+1 additional wet room	0.87	89%
Kitchen+2 additional wet rooms	0.98	88%
Kitchen+3 additional wet rooms	1.13	87%
Kitchen+4 additional wet rooms	1.4	86%

## CONTROLS

Ideal indoor air quality is achieved by automatically **adjusted ventilation**

Adroit DV96 is controlled via 4 ventilation profiles controls providing the following features:

- **4 ventilation profiles**, 100% adjustable
- **Internet** connection available
- **Automatic boost function** with delay timer
- **Filter maintenance reminder** via counter clock (standard)
- **Heater control** for optional post-heater
- **Connection to BMS** via LON or KNX
- **Self diagnostic** via fault signal relay
- **On-demand control** via humidity and CO<sub>2</sub> sensors
- **Separate fan control** for ease of commissioning
- **Weekly ventilation programming** allows users to pre-set the ventilation levels scheduled for different days
- **Indoor temperature control** based on extract air temperature or supply air temperature

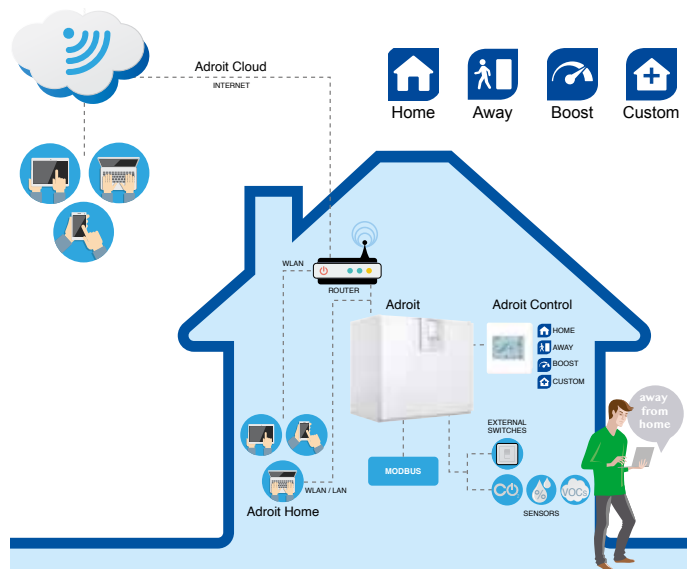

Call: 01494 525252

Visit: [airflow.com](http://airflow.com)



Airflow Developments Limited  
Aidelle House, Lancaster Road,  
Cressex Business Park,  
High Wycombe, Buckinghamshire,  
United Kingdom, HP12 3QP

E-mail: [info@airflow.com](mailto:info@airflow.com)  
Telephone: +44 (0) 1494 525252

[airflow.com](http://airflow.com)

© Airflow Developments Limited. Airflow Developments Limited reserve the right, in the interests of continuous development, to alter specifications without prior notice. All orders are accepted subject to our conditions of sale which are available on request

80000501 - Issue 4 09/23

