

Sentinel

Kinetic 200Z & 200ZH
300Z & 300ZH



Installation & Commissioning



| Model | Stock Ref. N° |
|-------|---------------|
| 200Z | 448733 |
| 200ZH | 449540 |
| 300Z | 447801 |
| 300ZH | 449536 |

Vent-Axia®

PLEASE RETAIN THESE INSTRUCTIONS WITH THE PRODUCT.



IMPORTANT



PLEASE READ THESE INSTRUCTIONS CAREFULLY BEFORE COMMENCING INSTALLATION.

1. DO NOT INSTALL THIS PRODUCT IN AREAS WHERE THE FOLLOWING MAY BE PRESENT OR OCCUR:

- EXCESSIVE OIL OR A GREASE LADEN ATMOSPHERE.
- CORROSIVE OR FLAMMABLE GASES, LIQUIDS OR VAPOURS.
- SUBJECT TO DIRECT WATER SPRAY FROM HOSES.
- AMBIENT TEMPERATURES HIGHER THAN 40°C AND LOWER THAN -10°C.
- POSSIBLE OBSTRUCTIONS THAT MAY HINDER ACCESS TO OR REMOVAL OF THE UNIT.

2. ALL WIRING MUST BE IN ACCORDANCE WITH THE CURRENT IEE WIRING REGULATIONS BS7671, OR APPROPRIATE STANDARDS OF YOUR COUNTRY. INSTALLATION SHOULD BE INSPECTED AND TESTED BY A SUITABLY QUALIFIED PERSON AFTER COMPLETION.

3. WHEN INSTALLING UNIT, TAKE CARE NOT TO DAMAGE ELECTRICAL OR OTHER HIDDEN UTILITIES.

4. THE INSTALLER IS RESPONSIBLE FOR THE INSTALLATION AND ELECTRICAL CONNECTION OF THE SENTINEL SYSTEM ON SITE. IT IS THE RESPONSIBILITY OF THE INSTALLER TO ENSURE THAT THE EQUIPMENT IS SAFELY AND SECURELY INSTALLED AND LEFT ONLY WHEN MECHANICALLY AND ELECTRICALLY SAFE.

5. ALL REGULATIONS AND REQUIREMENTS MUST BE STRICTLY FOLLOWED TO PREVENT HAZARDS TO LIFE AND PROPERTY, BOTH DURING AND AFTER INSTALLATION, AND DURING ANY SUBSEQUENT SERVICING AND MAINTENANCE.

6. THE UNIT SHOULD BE PROVIDED WITH A LOCAL DOUBLE POLE FUSED SPUR FITTED WITH A 3A FUSE HAVING A CONTACT SEPERATION OF AT LEAST 3mm.

7. ENSURE THE MAINS SUPPLY (VOLTAGE, FREQUENCY AND PHASE) COMPLIES WITH THE RATING LABEL.

8. THESE UNITS MUST BE EARTHED.

9. SENTINEL AIR HANDLING UNITS ARE DESIGNED AND SPECIFIED FOR USE WITH VENT-AXIA CONTROLS, DAMPERS, GRILLES AND ACCESSORIES.

10. THE UNIT'S CONDENSATE DRAIN MUST BE CONNECTED TO THE BUILDING'S FOUL WATER DRAINAGE SYSTEM.

11. IF THE EXTRACT GRILLE ASSOCIATED WITH THE UNIT IS SITED IN A ROOM CONTAINING A FUEL BURNING APPLIANCE THE INSTALLER MUST ENSURE THAT AIR REPLACEMENT IS ADEQUATE FOR BOTH APPLIANCES

12. CERTAIN APPLICATIONS MAY REQUIRE THE INSTALLATION OF SOUND ATTENUATION TO ACHIEVE THE SOUND LEVELS REQUIRED.

13. THE UNIT MUST NOT BE CONNECTED DIRECTLY TO A TUMBLE DRIER.

14. THE SUPPLY AND EXHAUST VALVES MUST BE FULLY OPENED PRIOR TO COMMISSIONING.

15. THE SUPPLY AIR MUST BE DRAWN FROM THE EXTERIOR OF THE PROPERTY.

16. THE INTERNAL CONDENSATE DRAIN AND ASSOCIATED PIPE WORK MUST BE CLEAR OF DEBRIS PRIOR TO COMMISSIONING.

17. THE SUPPLY AND EXHAUST CEILING VALVES MUST BE POSITIONED A MINIMUM OF 300 mm FROM A WALL TO ENABLE THE AIRFLOW MEASURING EQUIPMENT TO FIT CORRECTLY OVER THE VALVE.

18. THE UNIT SHOULD BE ALLOWED TO STABILISE DURING COMMISSIONING FOR A MINIMUM PERIOD OF 5 MINUTES WHEN CHANGING BETWEEN BOOST AND NORMAL SPEEDS.

19. WHEN FITTED TO A NEW BUILD PROPERTY THE SUPPLY AND EXHAUST FILTERS SHOULD BE CHECKED AT ONE MONTH INTERVALS FOR THE FIRST SIX MONTHS.

20. THIS APPLIANCE IS NOT INTENDED FOR USE BY YOUNG CHILDREN OR INFIRM PERSONS WITHOUT SUPERVISION.

21. YOUNG CHILDREN SHOULD BE SUPERVISED TO ENSURE THAT THEY DO NOT PLAY WITH THE APPLIANCE.

22. WHEN THIS UNIT IS USED IN CONJUNCTION WITH AN OPEN FLUE APPLIANCE, AN ELECTRICAL DUCT HEATER MUST BE PLACED IN THE SUPPLY (COLD FRESH AIR DUCT COLOUR MARKED GREEN) WHEN USED IN BYPASS MODE.

23. PRECAUTIONS MUST BE TAKEN TO AVOID THE BACKFLOW OF GASES INTO THE ROOM FROM THE OPEN FLUE OF GAS OR OTHER FUEL BURNING APPLIANCES. ENSURE THAT THE UNIT'S EXTERNAL GRILLE ARE A MINIMUM OF 2 m APART AND LOCATED AT LEAST 600 mm AWAY FROM ANY FLUE OUTLET.

24. IF THE DUCTWORK OR CONDENSATE PIPE PASSES THROUGH AN UNHEATED LOFT VOID OR SIMILAR LOCATION IT SHOULD BE INSULATED.

Disposal

This product should not be disposed of with household waste. Please recycle where facilities exist. Check with your local authority for recycling advice.



Contents

| | |
|-------------------------------------------------------|-----------|
| Product Description | 4 |
| Sentinel Kinetic 200Z, 200ZH & 300Z, 300ZH | 4 |
| Technical Data | 5 |
| Overview | 6 |
| Before Installation of the Unit | 6 |
| Unit Installation | 6 |
| Installation of Unit Brackets | 7 |
| Dimensions and Ducting for the Sentinel Kinetic | 10 |
| Attaching the ducting | 10 |
| Powering Up the Unit | 14 |
| Remote Wired Control Display | 14 |
| Start-up Screens | 15 |
| Commissioning | 19 |
| Overview | 19 |
| Commissioning Screens | 20 |
| Maintenance | 30 |
| Filter Maintenance | 30 |
| 12 Monthly Maintenance | 30 |
| Spares | 33 |
| Troubleshooting | 34 |
| Diagnosing a Problem | 34 |
| Appendix: Options and Accessories | 35 |
| CO2 / Temperature Sensor | 35 |
| Normal / Boost switch | 35 |
| Humidistat | 35 |

UK Building Regulations (ADF) Declaration of Conformance

The Sentinel Kinetic conforms to the 2010 Building Regulations (Approved Document F - Means of Ventilation) for installed performance of a ducted mechanical extract fan when installed in accordance with the instructions in this document.

Note: Read in conjunction with Operating and Monitoring manual 449355.

Product Description

Sentinel Kinetic 200Z, 200ZH & 300Z, 300ZH

The Vent-Axia **Sentinel Kinetic Mechanical Ventilation / Heat Recovery (MVHR)** heat recovery unit is designed for the energy efficient ventilation of houses and similar dwellings, conforming to the latest requirements of the Building Regulations document F 2010.

The unit is designed for continuous 24 hour exhaust ventilation of stale moist air from bathrooms, toilets and kitchens. As the stale air is extracted, a heat exchanger within the unit transfers the heat into the supply air entering the bedrooms and lounge.

Sentinel Kinetic 200Z, 200ZH & 300Z, 300ZH Summer By Pass.

The Sentinel Kinetic is fitted with a Summer By Pass (SBP) and will provide energy-free heating and energy-free cooling when the house temperature and ambient temperature allows.

If the room is warmer than the set (shown as "indoor") temperature (i.e. you need the room to be cooler) and the outdoor air is cooler than the actual room temperature (i.e. the outdoor air could cool your room) then the SBP will open and the unit will supply cooler air to your room.

If the room is cooler than the set ("indoor") temperature (i.e. you need the room heating) and the outdoor air is warmer than the actual room temperature (i.e. the outdoor air could heat your room) then the SBP will open and the unit will supply warmer air to your room.

Note that the above only applies whilst the outdoor air temperature is above 14C (adjustable) in order to prevent cold draughts.

The set ("indoor") temperature should be set 2 or 3 degrees higher than the central heating thermostat and 2 or 3 degrees below any air conditioning thermostat if fitted. This will prevent any clash between the separate systems

Models

1. **448733 - Sentinel Kinetic 200Z** with Summer Bypass and Wired Remote Control.
2. **449540 - Sentinel Kinetic 200ZH** with Summer Bypass, Integral humidity sensor & Wired Remote Control.
3. **447801 - Sentinel Kinetic 300Z** with Summer Bypass and Wired Remote Control.
4. **449536 - Sentinel Kinetic 300ZH** with Summer Bypass, Integral humidity sensor & Wired Remote Control.

Accessories

- **441838** - Sentinel Kinetic plug-in integral humidity sensor
- **441780** - Vent-Wise accessory pack (Requires sensors)
- **447340** – Opto Coupler

A range of sensors can be used to manage system demand and control the ventilation rate. These include an internal humidity sensor, humidity sensors for independent mounting in rooms, CO₂ sensor, Vent-Wise sensors, manual switches and pull cords. For these alternative control options, see www.vent-axia.com

Technical Data

| Performance | Sentinel Kinetic 200Z & 200ZH | Sentinel Kinetic 300Z & 300ZH |
|------------------------------------|-------------------------------|-------------------------------|
| Airflow | See Graph below | See Graph below |
| Power | | |
| AC Voltage Input | 220-240 V AC (single phase) | |
| AC Frequency Input | 50 Hz nominal | |
| Supply Fuse | 3 A (located in fused spur) | |
| Product Fuse | 2 A (located on main PCB) | |
| Rated Power | 150W (max.) | 150W (max.) |
| Physical | | |
| Height excluding mounting brackets | 200mm | 300mm |
| Width | 570mm | 700mm |
| Length excluding spigots | 800mm | 890mm |
| Weight | 26kg | 38kg |
| Spigot diameter | 125 mm | 150 mm |
| Condensate pipe diameter | 22 mm | |
| Environmental | | |
| IP Rating | IP22 | |
| Operating Temperature | -10°C to +45°C | |
| Operating Humidity | 0% to 95% RH | |

For all other technical details, please see the Product Catalogue or our website at www.ventaxia.com

Performance Graph 200Z & 200ZH

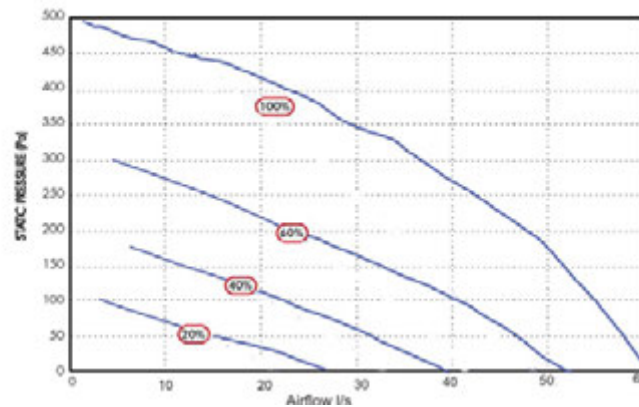

Performance Graph 300Z & 300ZH

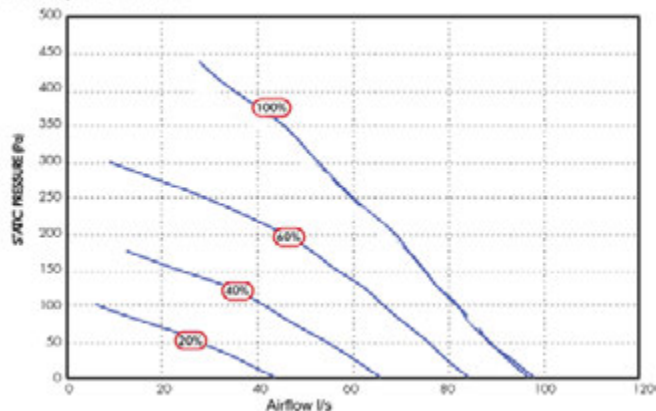

Overview

The following instructions are intended to help prevent potential hazards and installation should only be carried out by a qualified electrician and installer.

NOTE: we advise installers to fix all mains, sensor wiring and wired remote control along with any internal accessories prior to fixing the MVHR unit in position.

Before Installation of the Unit

Inspect the Unit

When taking delivery of the unit, check the items delivered against the enclosed delivery note. Inspect the unit for damage in transit. If in doubt, contact Customer Services. Each box contains a Kinetic unit and ceiling mounting brackets and product documentation.

Lift and Move the Unit Safely

Check the weight of the unit that you are installing. Always use appropriate lifting techniques and appliances when moving heavy equipment.

Check Site Requirements and Safety Notices

Check that the physical and environmental conditions for the site meet, or exceed, the requirements detailed in the *Technical Specification*.

Unit Installation

The unit **MUST** always be mounted horizontally. Do not use this unit as a support for any other equipment.

The ceiling should have sufficient strength to support the unit.

Take into consideration the position of the electrical services and the condensate drain.

Ensure there is adequate access for installation, operation and maintenance.

It is recommended that a local disconnection mains and sensor terminal box is installed within 1m of the unit to facilitate future maintenance.

Ceiling Mounting

Fix the 2 Brackets to the ceiling, the fixings must be suitable for the surface type intended (concrete, wood) they must also be compatible for the units weight , 200 Z & ZH = 26Kg - 300Z & 300ZH = 38Kg

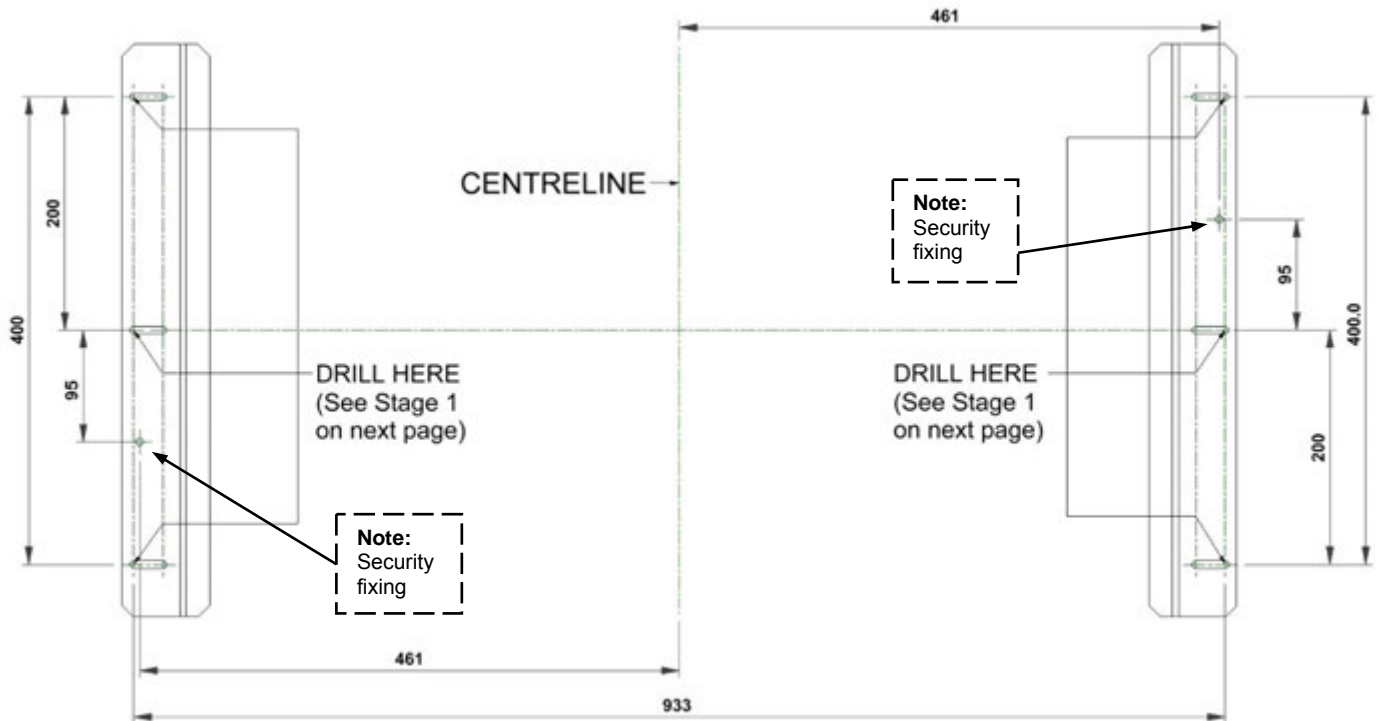

200Z & 200ZH

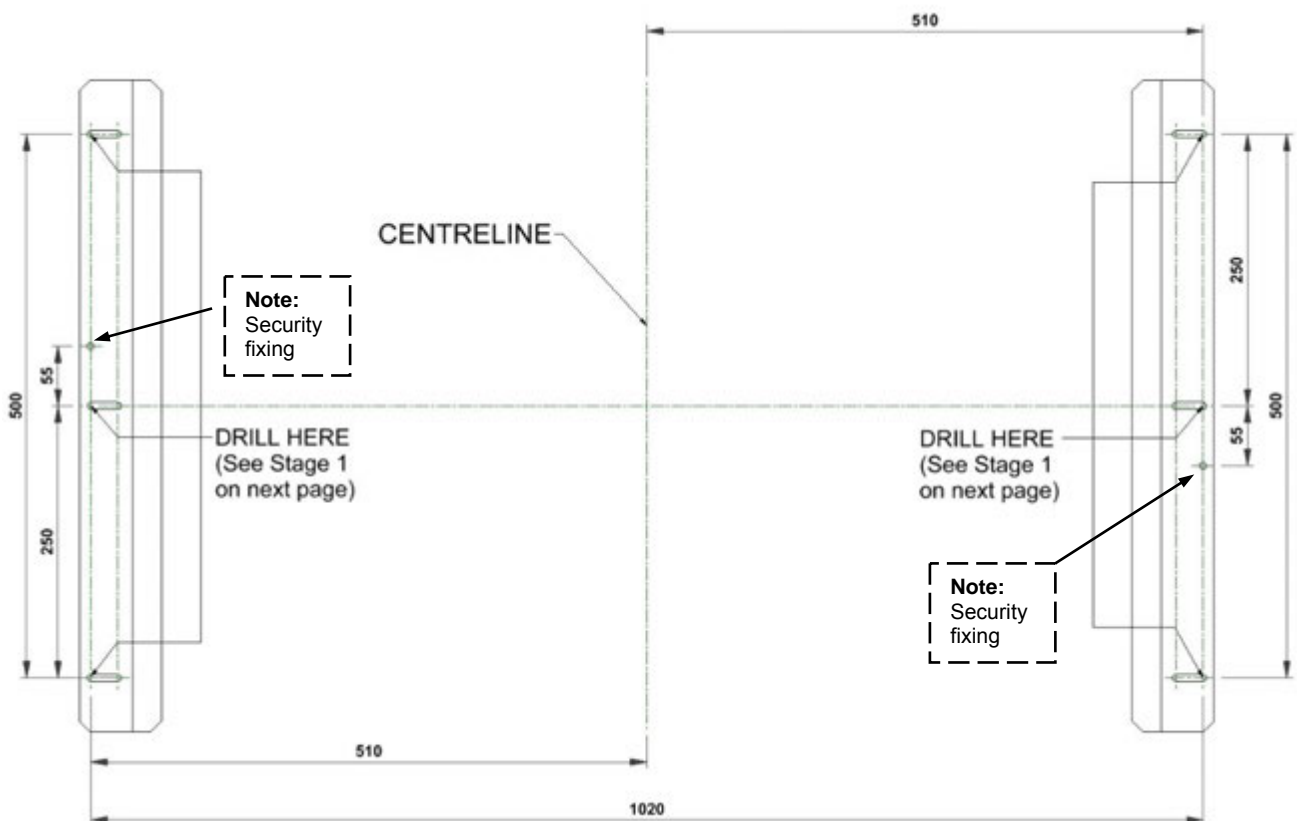

300Z & 300ZH

Installation of Unit Brackets

Stage 1: Drill the holes according to the guide on the previous page; make sure the holes you drill enable the brackets to be moved apart within the guide holes on the bracket.



Stage 2: Place each of the bolts into position and **do not** fully tighten. Leave approximately “a half turn” loose on each of the fixings. This will allow each bracket to be moveable until final fitting of the unit and makes any adjustments easier while installing the unit in position.



Stage 3: The brackets are in their approximate location and the unit can now be raised into position.

Once the unit is in its located position, the brackets can be moved and secured.

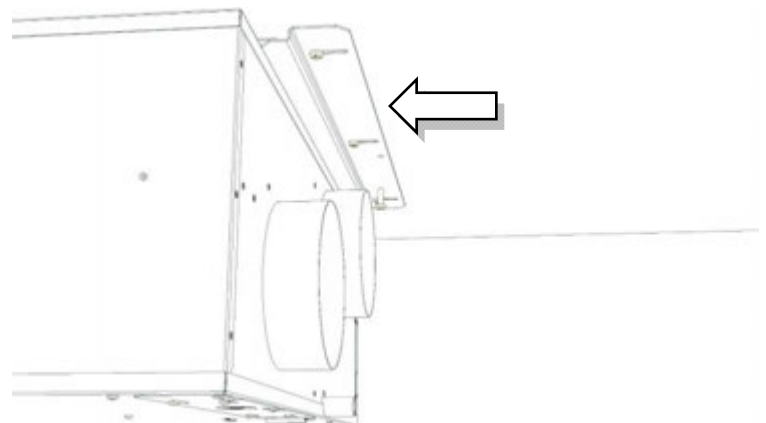

Stage 4: Finally, with the unit secure you can now fix the security fixing (as pictured right).

Once secured you may proceed with the rest of the installation.

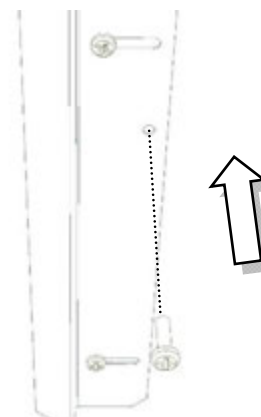

Connecting the condensate drain

There are two ways of connecting the condensate drain of the unit, which is dependent on the installation scenario.

Install A: U-Trap configuration (22mm Waste)

Using a 22mm (dia) fitting the U-Trap is formed of four 90(deg) elbow bends and 22mm standard waste pipe to connect between the elbows. A further 22mm (dia) waste pipe then connects to the unit's drainage via an inline 22mm (dia) coupler.

Please note you must ensure that there is a minimum of a 3(deg) downward angle to allow water to drain away from the unit naturally.

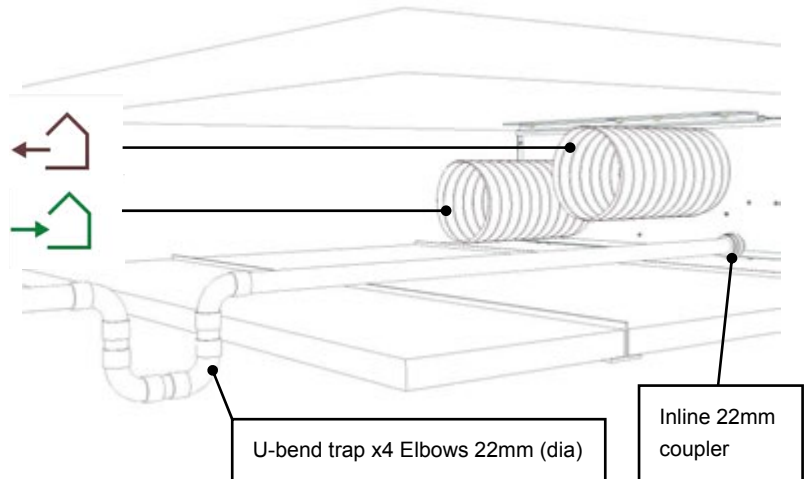

Install B: In-line configuration (32mm/22mm waste)

For installations in a ceiling void where it is too shallow for a traditional U-Trap configuration. Our recommendation is to use a HepVO inline waste valve and Tundish Adaptor kit (Part number: BV1/21-32mm). The Tundish adaptor will allow a connection to the existing 22mm dia condensate leaving the unit via an inline 22mm coupler.

However the opposite exhaust end of the HepVO valve will require a 32mm Waste pipe connection to exhaust waste from the property.

All mentioned parts are available from your nearest Plumbing trade centre.

Please Note: In areas where cold conditions inc frost are possible, outlet pipes must be insulated to avoid blockage and potential damage to the unit and surroundings.

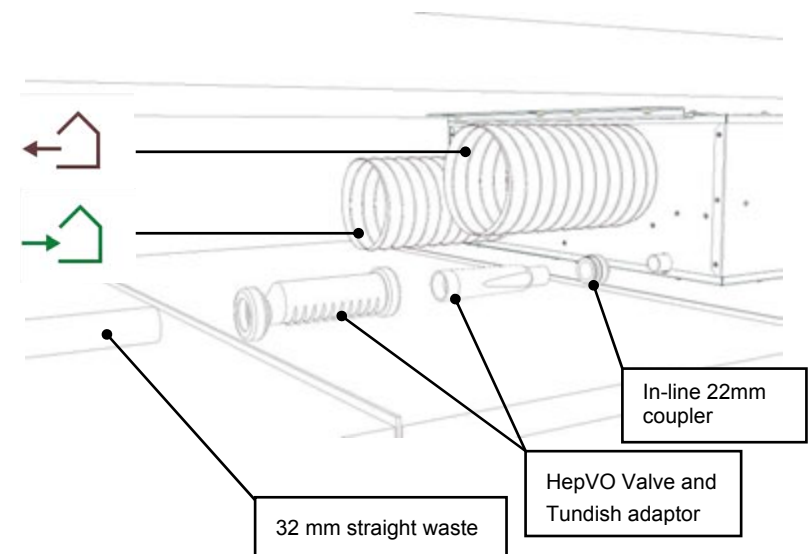

Dimensions and Ducting for the Sentinel Kinetic 200Z & 200ZH (300Z & 300ZH)

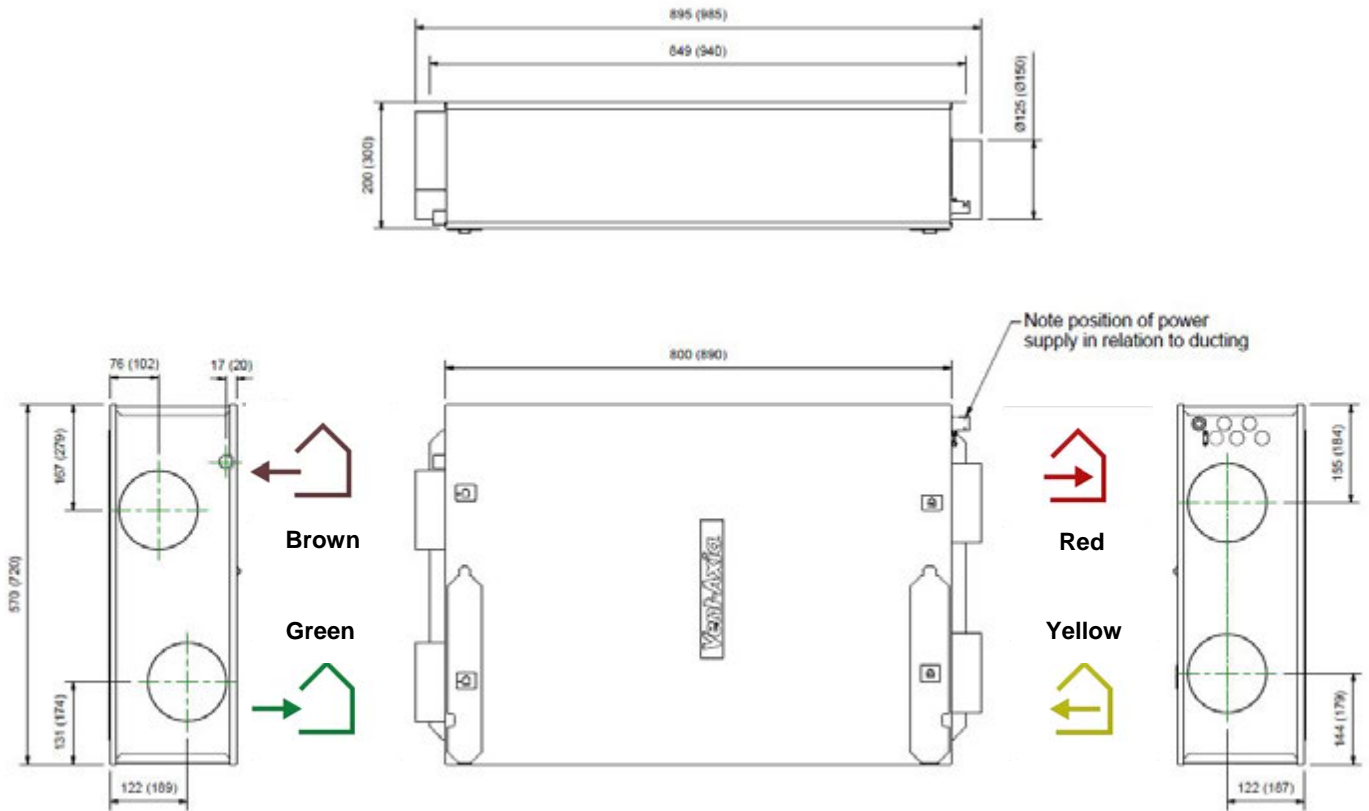

KEY:



Attaching the ducting

1. Always use a short piece of flexible ducting 100-150mm long, extended to its full length when connecting to ductwork.
2. Securely connect this ducting to the spigots using worm-drive clips or cable ties and duct tape.
3. Insulate any ducting passing through an unheated space to prevent any heat losses and surface condensation.

Electrical Installation

Connect the Wired remote Control



1. The Wired remote Control uses a 15 metre long cable to connect to the unit, it can be permanently mounted in a living space for the end user or used for commissioning the unit.
2. Fit the 15 metre Remote Control cable plug into the cable socket fitted to the Heat Recovery Unit.

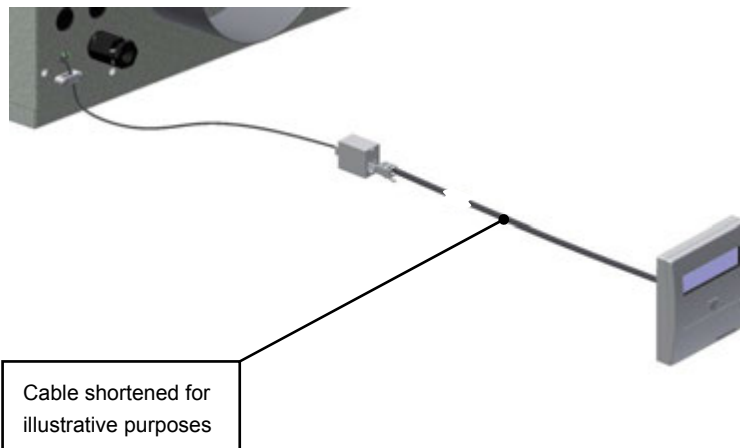

3. Connect the cable assembly to the Remote Control terminal block (the terminal block is colour coded to match the individual coloured cables and mount onto a single gang recessed wall box with the 2 screws provided).

The wired remote Control will automatically be detected.

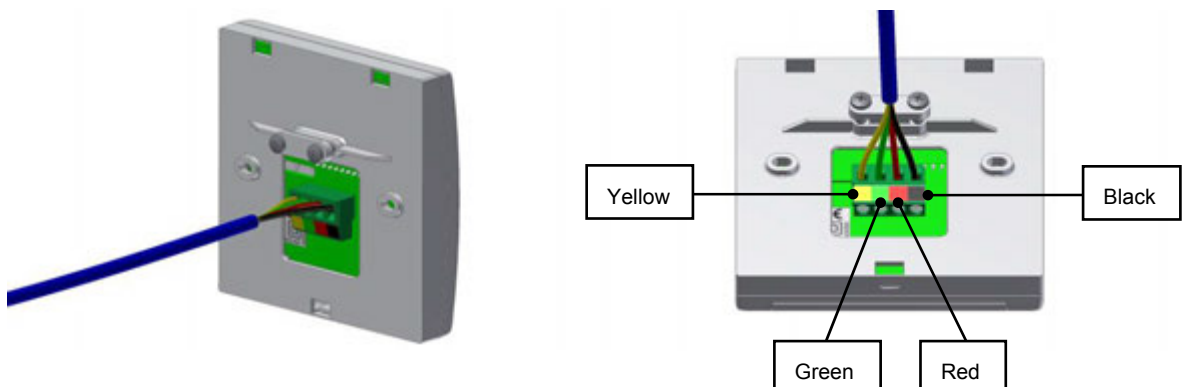

Connect Switches and Sensors

The unit can be switched to boost by a variety of methods:

- Applying 240 V to the LS input.
- Switching across 1 of 5 pairs of switch terminals.
- Applying between 0 and 10 V as a proportional input to two input terminals.

In addition, fitting a Vent-Wise Accessory to the unit means that switch terminals 1-3 can be connected to be switched by a current detector (for example, detecting a hob being switched on) or a temperature sensor (for example, detecting the flow of hot water). Terminal 4 can be used in conjunction with a momentary switch or switches.

Connect any switches or sensors required to control the unit by connecting to the terminal connectors at the bottom of the control unit as shown below and in Table 1. If necessary contact Vent-Axia regarding the wiring and fixing of accessories and sensors.

Ensure that you use a grommet or gland to protect against potential water ingress.

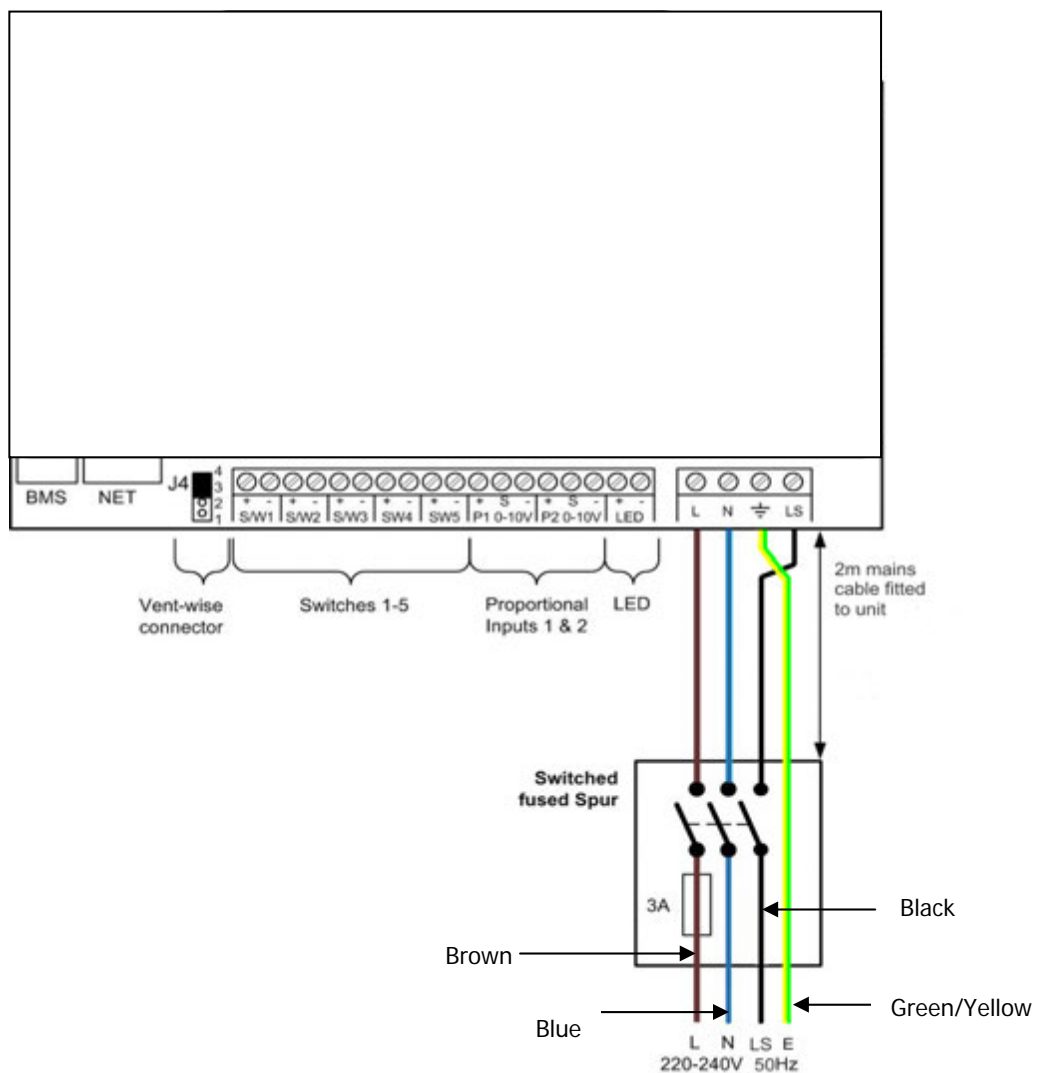



Table 1: Terminal Connections



| | Name | Description |
|----------|---------------------------------|--------------------------------------------------------------------------------------------------------------------------------------------------------------------------------------------------------|
| S/W1 | Switch 1 | With link fitted on J4 - activates volt-free contact for sensor input between + and - terminals |
| S/W2 | Switch 2 | |
| S/W3 | Switch 3 | |
| SW4 | Switch 4 | With Vent-Wise PCB fitted to J4 - enables Vent-Wise sensor input Note do not fit standard sensors or Volt- free switch contact in this mode. |
| SW5 | Switch 5 | Volt-free contact for sensor input between + and - terminals With Vent-Wise PCB fitted to J4 - enables Vent-Wise momentary switch input |
| P1 0-10V | Proportional 1 | A 24 V DC sensor supply is output between the + and - terminals. A 10 V proportional sensor input is received between S and - terminals |
| P2 0-10V | Proportional 2 | A 24 V DC sensor supply is output between the + and - terminals. A 10 V proportional sensor input is received between S and - terminals |
| LED | Red Light Emitting Diode Output | A 5 V LED driving signal output between the + and - terminals that enables remote indication of a unit fault. See the Control Panel for fault code (see <i>Service/Fault Code Screens</i> on page 34). |
| L | Mains Live | 220-240 V AC, 50 Hz input |
| N | Mains Neutral | 220-240 V AC, 50 Hz input |
| EARTH | Mains Earth | Earthing connector |
| LS | Switched Live | 220-240 V AC, 50 Hz input |

Connect the Power Supply



WARNINGS

1. MAINS SUPPLY VOLTAGES (220-240 V AC) ARE PRESENT IN THIS EQUIPMENT WHICH MAY CAUSE DEATH OR SERIOUS INJURY BY ELECTRIC SHOCK. ONLY A QUALIFIED ELECTRICIAN OR INSTALLER SHOULD CONNECT THE POWER SUPPLY TO THIS UNIT.
2. THIS UNIT MUST BE CORRECTLY EARTHED.

This unit is designed for operation from a single-phase alternating current source (220-240 V AC). A 2 m cable is connected internally to the unit for connection to a switched fused spur.

To connect the power supply:

1. Ensure the local AC power supply is switched off.

One end of the power cable supplied is already connected to the unit.

Connect the other end of the cable to the switched fused spur.

Use cable clamps and clips to secure the cable, as appropriate.

Connecting a Boost (Light) Switch

A Switched Live (LS) may be used to boost the airflow when a light is turned on, for instance in a bathroom or kitchen.

Power supplied to the unit via a Switched Fused Spur must be supplied via the same circuit as the LS connecti

Powering Up the Unit

Switching On

To switch the unit on:

1. Switch on the power at the mains supply isolator feeding the unit.
2. Following switch-on, the fan motors will start and the Remote Wired Control will display a series of start-up screens, described below.

N.B. If you are intending to carry out work or maintenance inside the unit, switch off the power at the mains outlet supplying the unit before you remove the covers.

Switching Off

To switch the unit off:

1. Turn the power off at the mains supply isolator.

Wired Remote Control Display



Display

The main display is an LCD, see overview on page 20.

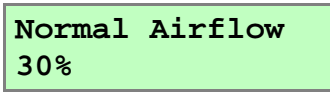

Buttons

Four buttons on the Control Unit provide the controls for configuring and monitoring the unit.

| Button | Function |
|--------|----------------------------------------------------------------------------------------------------------------------------------------------------------------|
| | Press to adjust settings and press to save settings. |
| | Press to go to the previous screen or to increase a parameter value. Press and hold for more than 2 seconds for fast scrolling. |
| | Press to go to the next screen or to decrease a parameter value. Press and hold for more than 2 seconds for fast scrolling. |
| | Press to activate Boost mode. See page 16 for options. Press and hold for 5 seconds to activate Purge mode. (Press and hold for 5 seconds to cancel Purge). |

Start-up Screens

Sentinel Kinetic Version Screen

The Sentinel Kinetic Version screen displays the firmware version number for 3 seconds.

No adjustments are possible on this screen.

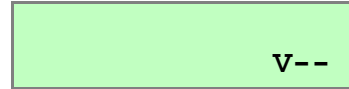

Language Screen

The Language screen displays the language used for the screens. It is typically displayed for 5 seconds, or longer if changing the setting.

(To re select a new language disconnect and then reconnect to the mains supply).

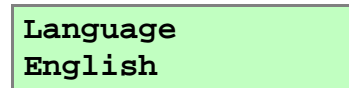

Control Mode Screen

This allows a choice between the control mode described in this document and an alternative control mode.

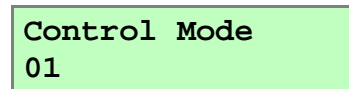

Airflow Units Screen

The Airflow Units is a percentage of the unit's maximum flow.

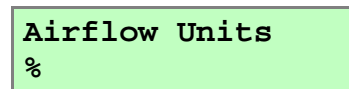

Wireless Control Screen

Not available.

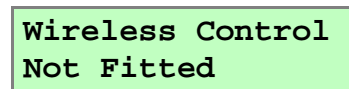

Humidity Sensor Screen

The Humidity Sensor screen displays whether the humidity sensor is fitted. It is typically displayed for 3 seconds.

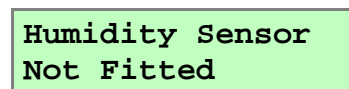

Low Airflow / Normal Airflow / Boost Airflow Screen

When the start-up screens are finished, the low or normal screen is displayed showing operating status (Low Airflow X % or Normal Airflow X % or Boost Airflow X %).

The Normal screen displays the rate of normal airflow (supply air) through the unit.

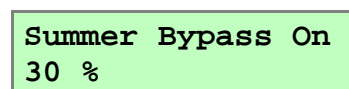
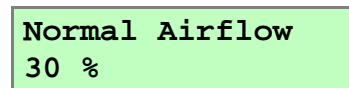

If the installation has proportional sensors or an internal humidity sensor fitted, an α symbol will be displayed when humidity sensor is boosting the airflow.

When the summer bypass is active, the normal screen top line will alternate (for 3 seconds) with Summer Bypass On.



An interval can be set, see page 28, at which the unit reminds the user to check the filters. The normal screen top line will include Check Filter as a reminder to check and, if necessary, clean or replace the filters.

Check Filter
30 %

When this has been done, press and hold the  and  buttons for 5 seconds to reset the automatic message.

Pressing the  button activates the boost airflow mode when extra ventilation is required.

Boost Airflow
50 %

| No. of presses | Boost action |
|----------------|--------------------------|
| 1 | Boosts for 30 minutes |
| 2 | Boosts for 60 minutes |
| 3 | Boosts continuously |
| 4 | Back to Normal flow rate |

If the wireless boost option is fitted, this can be triggered from the wireless transmitter/boost switch.

If the installation has switch sensors, is wired to the lighting, has Vent-Wise sensors, Vent-Wise momentary switch or if the internal time switch is set for periodic operation, operation will change from normal to boost automatically. Pressing the  button will reveal a code to show which device has activated boost.

s1 = Switch S/W1

s2 = Switch S/W2

s3 = Switch S/W3

s4 = Switch SW4

s5 = Switch SW5

v1 = Vent-Wise Input S/W1

v2 = Vent-Wise Input S/W2

v3 = Vent-Wise Input S/W3

ls = Switched live (LS)

c1-3 = Internal Time switch

If running on boost due to pressing the  button, another device may 'take over' the boost. Flow will return to normal when that device switches off. If a number of different devices are calling for boost flow, the unit will run at boost until the last one has reverted to normal.

Purge Screen

Pressing and holding the button for approximately 5 seconds activates purge mode when you want to purge air from the building. The unit will revert to normal flow by pressing and holding the button again for 5 seconds. If the wireless boost option is fitted, purge can be triggered from the wireless transmitter/boost switch.

Purge mode runs the fans at full speed for 2 hours (120 minutes). The Purge screen displays a countdown of the time remaining.

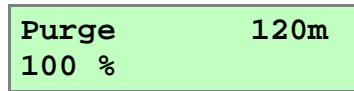

Low Airflow Screen

Low Airflow mode is activated when the Normal Airflow is set to **Off**.

The Normal Airflow mode can be set to run during the daytime i.e. from 6am to 11pm, the Low Airflow mode will then run during the night from 11pm to 6pm.

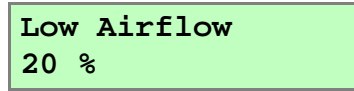

Set Clock Screen

From the Normal Airflow screen, simply press the button once to access the Set Clock screen.

The Set Clock Control screen enables you to change the clock settings. The clock retains its settings for approximately two weeks without mains power, after which it will need resetting when power is reconnected. Values are **DDD HH:MM**.

Return to the normal display by pressing the button or leave to timeout and return automatically after 2 minutes.

The unit will not automatically switch for daylight saving time.

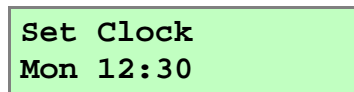

Summer Mode Screen

From the Normal Airflow screen, simply press the button twice to access the Summer Mode screen.

If the unit is a summer bypass model, the Summer Mode screen enables you to switch the summer bypass control on or off. This screen is only displayed when the bypass is fitted.

Options available are **On** (default) and **Off**.

Return to the normal display by pressing the button or leave to timeout and return automatically after 2 minutes.

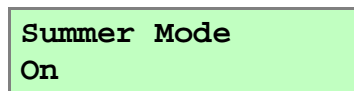

Indoor Temp Screen

From the Normal Airflow screen, simply press the  button until the Indoor Temp screen is displayed.

The Indoor Temp screen enables you to choose the target room temperature in degrees Centigrade – only displayed when the bypass is fitted.

Selectable range is **16-40** (**25** default).

Return to the normal display by pressing the  button or leave to timeout and return automatically after 2 minutes.

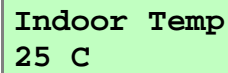

This function will only work when the Summer Mode is set to on.



Indoor Temp
25 C



Outdoor Temp Screen

From the Normal Airflow screen, simply press the  button until the Indoor Temp is displayed. Press  button to choose the required temperature and then press  button again to confirm the entry and this will call up Outdoor Temp.

The Outdoor Temp screen enables you to choose the minimum outdoor temperature at which the bypass will operate in degrees Centigrade – only displayed when the bypass is fitted.

Use this to prevent cold draughts being introduced.

Selectable range is **5C – 20C** (**14C** default).

Return to the normal display by pressing the  button or leave to timeout and return automatically after 2 minutes.

This function will only work when the Summer Mode is set to on.

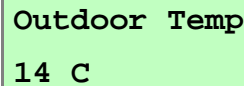

Outdoor Temp
14 C



Commissioning

Overview

The instructions in this section are intended to provide configuration and operation information for setting up the equipment. In the event of problems, see *Troubleshooting* on page 34

Follow good practice when commissioning the unit. Ensure that the system is installed according to the system designers intent incorporating any acoustic ducting, that all joints are air tight, ducting is well supported, bends are avoided close to vents, and that the vent valves are fully open at the start of the commissioning process.

The following is attached to the unit and should be used as a check list prior to setting the air flows.

Vent-Axia.

MVHR Installation Checklist

REQUIRED TO BE COMPLETE TO COMPLY WITH CONDITIONS OF WARRANTY,
but does not affect statutory rights.

This is a short check list of good practice do's and don'ts that may affect the safety or functionality of the installation. It is not a complete list of what is required. They must be complied with in order to ensure that the installation performs as expected.

Unit Serial number: _____ Installer's name: _____

| Check | | | Date and initials |
|--------------------------------------------------------------------------------------------------------------------------------------------------------|--|--|-------------------|
| 1. Is the unit stable and horizontal with room around it to allow maintenance? | | | |
| 2. Is any flexible ducting pulled taut to prevent moisture collection and avoids airflow issues? | | | |
| 3. Is any flexible ducting crushed which will cause airflow issues? | | | |
| 4. Are all joints in the ductwork sealed to prevent air leakage? | | | |
| 5. Is the ducting insulated to prevent condensation and cooling or heating of the air? | | | |
| 6. Does the condensate drain a) have the correct slope to ensure water runs away and b) is fitted with a trap to prevent smells coming back into unit? | | | |
| 7. If the condensate drain passes through a cold space is it insulated to prevent freezing? | | | |

See the Installation Guide and Checklist at: http://www.vent-axia.com/files/domestic_ventilation_compliance_guide_2010.pdf

Wired remote Control Screens Summary

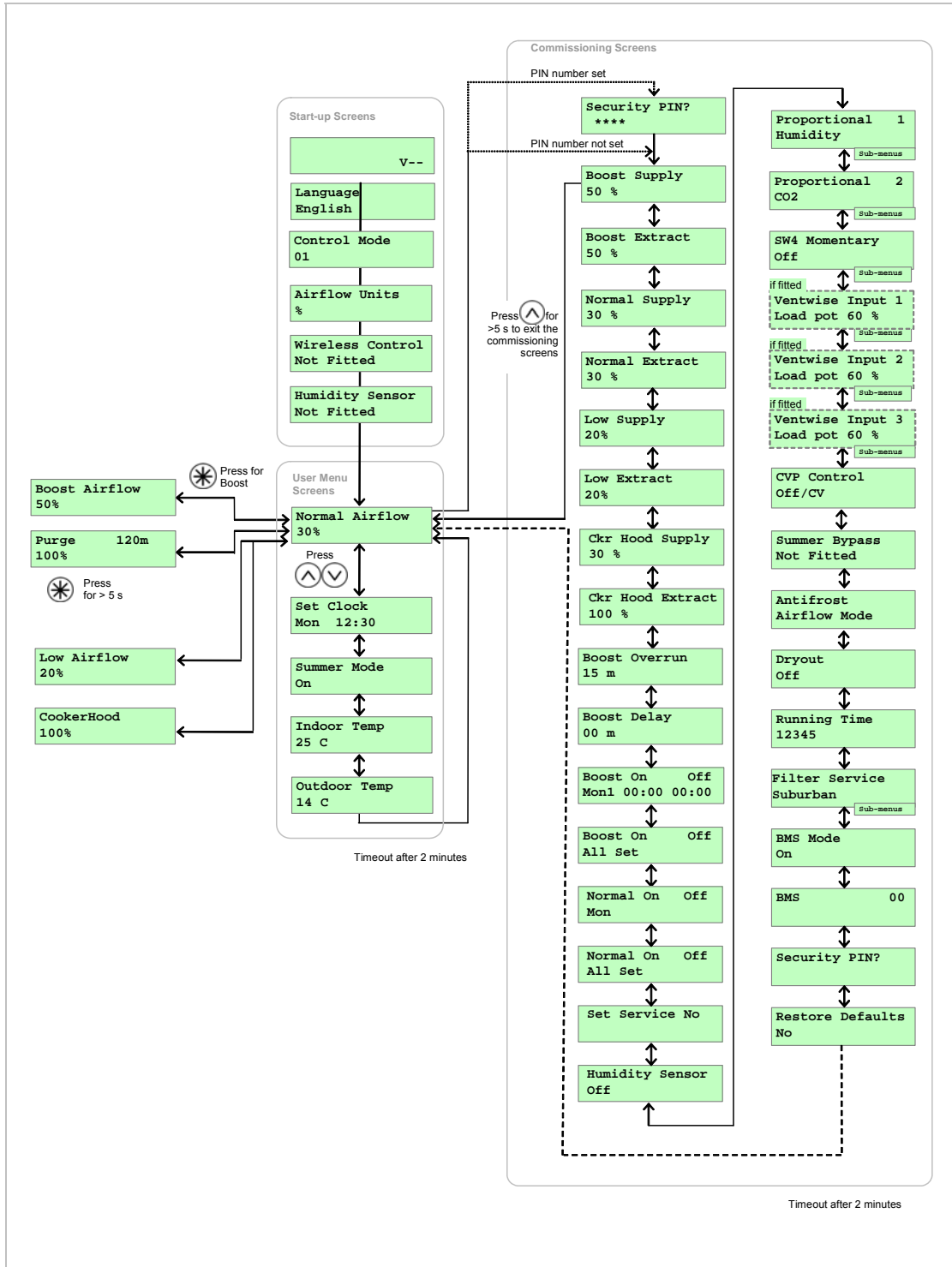

Commissioning Screens

The commissioning screens enable you to configure the operational settings of the unit. Settings are stored in a non-volatile memory and will be retained irrespective of mains supply breaks.

Note: Access to the commissioning screens is prevented if the display shows **Antifrost Active**, **Room Too Cold** or a **Fault Code**. In this event, switch the unit off and on again and enter the commissioning screens within one minute. If you are within the commissioning screens the Antifrost and Room Too Cold Failures modes will not operate allowing the flow rates to be adjusted even in a property which is below 5C.

To access the commissioning screens: Press and hold the , and buttons for 5 seconds.

Start with SET followed by UP then Down arrows.

To return to the normal screen, either press and hold the button to reach the first menu item and then hold for a further 5 seconds. Alternatively, the normal display will resume if no buttons are pressed for two minutes.

Security PIN Screen

If a security PIN code has been previously set, this screen will display ****.

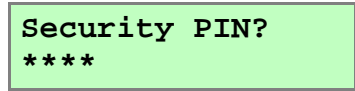

Enter the PIN using , and buttons.

Note 1
 Whilst displaying the Low, Normal, Boost Supply, Low, Normal, Boost Extract screens the fans will run at the displayed % flow and the bypass will remain shut. The two-minute automatic return to normal display time is extended to four hours to allow time for measurements or adjustments.

Boost Supply Screen

The Boost Supply screen enables you to set the Boost airflow speed for the Supply fan in order to balance out any differences in ductwork or other installation features.

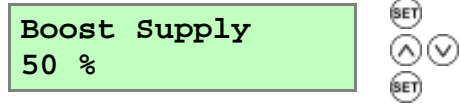

Default Boost speed = 50%.

The Boost speed cannot be set above the Cooker Hood speed or below Normal speed setting.

Boost Extract Screen

The Boost Extract screen enables you to set the Extract airflow speed for the Extract fan in order to balance out any differences in ductwork or other installation features.

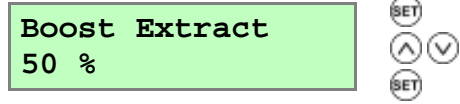

Default Boost speed = 50%.

The Boost speed cannot be set above the Cooker Hood speed or below Normal speed setting.

Normal Supply Screen

The Normal Supply screen enables you to set the Normal airflow speed for the Supply fan in order to balance out any differences in ductwork or other installation features.

Default Normal speed = 30%

The Normal speed cannot be set below Low speed or above Boost speed setting.

Normal Supply
30 %



Normal Extract Screen

The Normal Extract screen enables you to set the Normal airflow speed for the Extract fan in order to balance out any differences in ductwork or other installation features.

Default Normal speed = 30%

The Normal speed cannot be set below Low speed or above Boost speed setting.

Normal Extract
30 %



Low Supply Screen

The Low Supply screen enables you to set the Low airflow speed for the Supply fan in order to balance out any differences in ductwork or other installation features.

Default Low speed = 20%

The Low speed cannot be set below 1% or above Normal speed setting.

Low Supply
20 %



Low Extract Screen

The Low Extract screen enables you to set the Low airflow speed for the Extract fan in order to balance out any differences in ductwork or other installation features.

Default Low speed = 20%.

The Low speed cannot be set below 1% or above Normal speed setting.

Low Extract
20 %



Cooker Hood Supply & Extract Screens

The Cooker Hood Supply & Extract screens are non-functional.

Ckr Hood Supply
30%

Ckr Hood Extract
100%

Boost Overrun Screen

The Boost Overrun screen enables you to set a time period for the fans to boost airflow (in minutes) after the light switch (LS input) is turned off. It will then return to normal airflow.

Selectable range: minimum = **00**, maximum = **25**, default = **15**.

Boost Overrun screen does not function for inputs SW1 to SW3 and SW4, SW5

Boost Overrun
15 m



Boost Delay Screen

The Boost Delay screen enables you to set the time delay (in minutes) from the light switch (LS input) being switched on to the airflow boost being activated. This is used to prevent the unit from boosting unnecessarily when the light switch is switched on for short periods.

Selectable range: min. = **00**, max. = **10**, default = **00**.

Boost Delay
00 m



Boost On/Off Screen

The Boost On/Off screen enables you to set a time for boost to be activated for each day of the week.

You can set up to three **On/Off** times per day, shown as **Day1**, **Day2** and **Day3**. If **On** and **Off** times are the same, the unit will not change speed.

On time cannot be set earlier than a previous off time, Likewise, **Off** time cannot be set earlier than a previous **On** time.

To set a weekly schedule:

Setting starts at **Mon1** and uses **SET** to show, by flashing, which item is available for adjustment with the **^** and **v** buttons (a → b → c → d → e → **Mon2** and so on).

Mon1 10:01 11:11

↑ ↑ ↑ ↑ ↑
a b c d e

When **Day** flashes, pressing ***** (> 2 sec) will copy yesterday's times to today.

Setting finishes when the last off minutes for **Sun3** are accepted, at which point the screen will now show

All Set or holding the **SET** button for 3 seconds.

Boost On Off
Mon1 00:00 00:00



Repeat for **Off**
Repeat for each **Day**.

Note: if same times are used on subsequent days, ***** will copy times found.

Boost On Off
All Set

Normal On/Off Screen

The **Normal Airflow** mode can be set to run during the daytime i.e. from 6am to 11pm, the **Low Airflow** mode will then run during the night from 11pm to 6pm.

The Normal On/Off screen enables you to set a time for Normal to be activated for each day of the week.

You can set up to one **On/Off** time per day, If **On** and **Off** times are the same, the unit will not change speed.

On time cannot be set earlier than a previous off time, Likewise, **Off** time cannot be set earlier than a previous **On** time.

To set a weekly schedule:

Setting starts at **Mon** and uses **SET** to show, by flashing, which item is available for adjustment with the **▲** and **▼** buttons (a → b → c → d → e → **Mon** and so on).

Mon 10:01 11:11

↑ ↑ ↑ ↑ ↑
a b c d e

When **Day** flashes, pressing ***** (> 2 sec) will copy yesterday's times to today.

Setting finishes when the last off minutes for **Sun** are accepted, at which point the screen will now show

All Set or holding the **SET** button for 3 seconds.

Normal On Off
Mon 00:00 00:00

SET (Day)

▲ **▼**

SET (Day)

SET (On)

▲ **▼**

SET (On)

Repeat for **Off**

Repeat for each **Day**.

Note: if same times are used on subsequent days, ***** will copy times found.

Normal On Off
All Set

Set Service No Screen

The Set Service No screen enables you to enter the telephone number that should be called for service in the event the unit fault.

Initially the screen is blank. Press **SET** to get a **0**. Use **▲** and **▼** buttons to change between **0** and **9** (or blank). Repeat until the number is entered. Finally, select a blank and press **SET** to finish. Maximum **16** digits.

Press and hold ***** for more than 2 seconds to clear service number.

Set Service No

SET

▲ **▼**

SET

Internal Humidity Sensor Screen (if fitted)

The Humidity Sensor screen enables you to switch the Sensor **On** and adjust the trigger point between 60% and 70 %. (default setting 70%).

Humidity Sensor
Off

SET

▲ **▼**

SET

Proportional 1 Screen

The Proportional 1 screen enables the conditions of the proportional sensors to be set.

The unit can receive a 0-10 V proportional signal from either a humidity, CO₂ or temperature external sensor, when connected to terminals P1.

By default, the Proportion 1 input is set for a humidity sensor operation.

When you have selected the sensor type, screens for the appropriate boost and normal limits are displayed.

Press **SET** and use the **▲** and **▼** buttons to change the selection (**Humidity**-default, **CO₂**, **Temperature**).

When the input signal is below the 'Normal Limit', the unit runs at low / normal airflow. When the signal is above the 'Boost Limit', the unit runs at boost airflow. Between these limits the unit runs at a proportional airflow.

For a humidity sensor, a percentage value must be entered for boost and normal settings. For range and default values, see *Table 2* below.

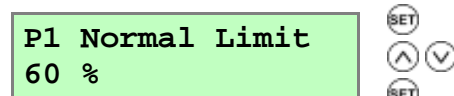
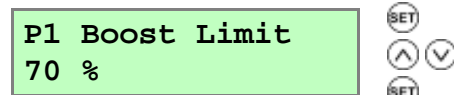
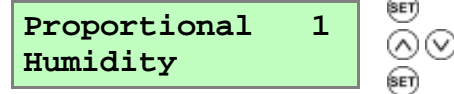

For a CO₂ sensor, a figure (in ppm) must be entered for boost and normal settings. For range and default values, see *Table 2* below.

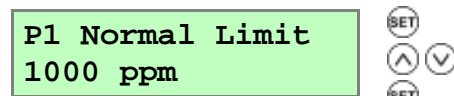
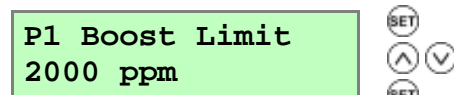

For a Temperature sensor, a figure (in degrees C) must be entered for boost and normal settings. For range and default values, see *Table 2* below.

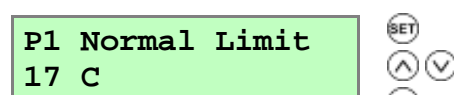
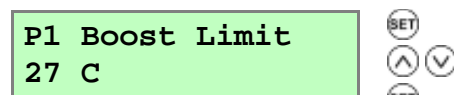

Table 2: Boost & Normal Limits – Defaults and Adjustment Range

| Sensor | Humidity | | CO ₂ | | Temperature | |
|--------------|-------------|-----------|-----------------|-------------|--------------|------------|
| | Default (%) | Range (%) | Default (ppm) | Range (ppm) | Default (°C) | Range (°C) |
| Boost limit | 70 | 25-90 | 2000 | 200-2000 | 27 | 10-35 |
| Normal limit | 60 | 25-90 | 1000 | 200-2000 | 17 | 10-35 |

Proportional 2 Screen

By default, the Proportional 2 input is set to CO₂ sensor operation.

See *Proportion 1 Screen* for a description.

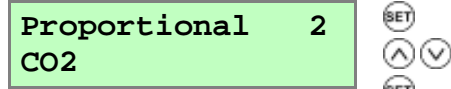

SW4 Screen

Momentary closure (1 sec) starts or stops boost for set time.

Selectable range: min. = **15**, max. = **30**.

Default = **Off** when no Vent-Wise card fitted.

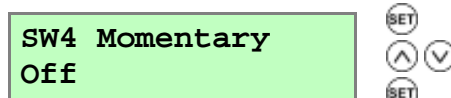

Vent-Wise Screens

These screens are only displayed if a Vent-Wise Card is fitted. Replacing J4 3-4 link with a Vent-Wise board converts S/W1, S/W2 and S/W3 from switch inputs to Vent-Wise inputs. In addition SW4 can be used by a momentary switch.

Vent-Wise sensors measure current or temperature. When the current or temperature exceeds a 'trip' level, boost airflow is selected. Low / Normal airflow is resumed after a timed delay once the current or temperature has dropped below the trip level.

Any of the sensor types can be connected to S/W1, S/W2 or S/W3 but once the Vent-Wise Card is fitted, ordinary switches must not be used.

In use, the Vent-Wise Card with three sensors will run hot to the touch albeit well below its maximum temperature. If any input is shorted (e.g. used with switch), the board will overheat and shut down.

Nominal trip level is with the Load Pot set to (60 %). A temperature sensor will trip with hot water at around 40°C and a current one around 1.5 A. Time Pot setting is from 1 to 25 minutes with a default of 20 minutes.

A one-second push on a momentary switch wired to SW4 will run boost for up to 25 minutes. The overrun timer can be set from 15 to 30 mins. A second one-second push will cancel the boost as would a "cancel boost" signal from one of the sensors. Multiple momentary switches may be wired in parallel to SW4.

Screens for each of the three switches are displayed. Enter a percentage value for the Load Pot setting.

* Shows Vent-Wise signal and indicates the unit is running in Boost mode

Selectable range: min. = **5**, max. = **95**, default = **60**.

Enter a time (in minutes) for the Time Pot setting.

Selectable range: min. = **1**, max. = **25**, default = **20**.

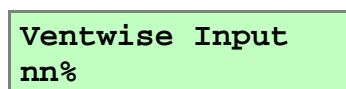
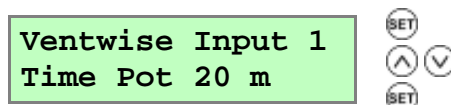
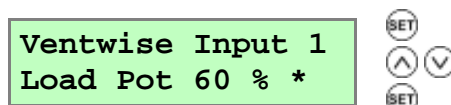

Momentary closure (1 sec) starts or stops boost for set time.

Selectable range: min. = **15**, max. = **30**.

Default = **25** when Vent-Wise card fitted

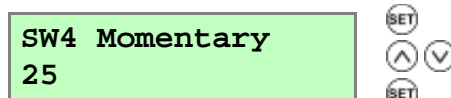

Summer Bypass Screen

The Summer Bypass screen is factory set if one has been fitted. It will only need resetting if a replacement control board has been fitted.

Available options = **Not fitted** (default) and **Fitted**.

Summer Bypass
Not Fitted



Antifrost Screen

The Antifrost screen is only displayed if a summer bypass is fitted. In installations where a negative pressure is not permitted during antifrost operation, set this to bypass mode.

Available options: **Airflow Mode** (default) and **Bypass Mode**.

Airflow Mode - When the supply air temperature is between 0° and -20°C, antifrost will automatically activate. This will reduce the supply airflow rate and increase the extract airflow rate to prevent frost forming on the heat exchanger. During antifrost operation the supply motor can stop for 15 minutes hour and run for 45, depending on the temperature below 0°C. If the supply air temperature is -20°C or below the supply fan switches off and the extract fan continues to run at reduced rate to prevent frost forming on the heat exchanger.

Bypass Mode - While the supply air temperature is below 0°C, the antifrost mode will automatically activate. This mode will open the bypass to prevent frost forming on the heat exchanger.

Antifrost
Airflow Mode



Dryout Screen

The Dryout screen enables the fans to be run at max speed for a week before returning to normal operation. This feature can help to dry out fresh plaster and paint enabling building work to be completed more quickly.

Filters may become fouled during this time and should be cleaned or replaced afterwards.

Available options: **Off** (default) and **On**.

Dryout
Off



Running Time Screen

The Running Time screen displays the total running time of the unit (in hours).

No changes may be made to this screen. In the event of power failure total time will be retained.

Running Time
12345

Filter Life

Press **SET** and then use the **▲** and **▼** push-buttons to select the time between Filter Services. The options are Urban (6 months), Suburban (default: 12 months) or Rural (18 months).

Filter Service
Suburban

BMS screen

On for BMS (default) or **Off** for Wired Remote Control, automatically set up by BMS signal or Wired Remote Control when either is plugged into BMS RJ11 socket.

BMS Mode
On

The BMS screen displays byte count and first 16 bytes from the Building Management System (BMS) system. The output may be controlled by a BMS system to switch the unit on or off for example in conjunction with a smoke alarm.

BMS **00**

No changes may be made to this screen.

Security PIN Screen

The Security PIN screen enables you to set a four-digit personal identification number (PIN) to access the commissioning screens. This screen will show blank if security is disabled and no PIN is used.

Security PIN?

Press **SET** to reveal **0000** with the first **0** flashing and use the **▲** and **▼** buttons to change the selection (**0-9**). Press **SET** again to accept the digit and move to the next. Repeat until all four digits are specified.

Press and hold ***** for more than 2 seconds to clear security PIN.

Restore Defaults Screen

The Restore Defaults screen enables you to restore the default settings for all screens.

Restore Defaults
No

Available options: **No** (default) and **Yes**.

The default commissioning settings are present when the unit is switched on and can be restored by setting the Restore Defaults screen to **Yes**



Table 3: Default Settings

| Parameters | Settings |
|--------------------------------|--------------------------------------------------------------------------------------------------------------------------|
| Start-up Screens | |
| Software version | V-- |
| Language | English. |
| Airflow Units | %. |
| Commissioning Screens | |
| Security PIN | Not set |
| Boost Supply/Extract | 50 % |
| Normal Supply/ Extract | 30 % |
| Low Supply/Extract | 20% |
| Cooker Hood supply / extract | 100% |
| Cooker Hood Antifrost Priority | On but can be set Off |
| Boost Overrun | 15 |
| Boost Delay | 00 |
| Boost On/Off | All days set to 0:00 (on), 00:00 (off) – inactive |
| Normal On Off | All days set to 0:00 (on). 00:00 (off) – inactive |
| Set Service No | Not set |
| Humidity | 70% |
| Proportional 1 | Humidity – Boost, Normal (60 %) CO2 – Boost (2000 ppm), Normal (1000 ppm) Temperature – Boost (27 C, Normal (17 C) |
| Proportional 2 | CO2 – Boost (2000 ppm), Normal (1000 ppm) Temperature – Boost (27 C, Normal (17 C) Humidity – Boost, Normal (60 %) |
| SW4 | Off, or with Vent-Wise card fitted 25 mins |
| Vent-Wise 1/2/3 | Load Pot (60 %) Time Pot (20 m) |
| Summer Bypass | Not Fitted |
| Antifrost | Airflow Mode |
| Dryout | Off |
| Running Time | - |
| Filter Life | Can be set to Urban Suburban and Rural |
| BMS | On |
| Restore Defaults | Off |
| User Screens | |
| Set Clock | - |
| Summer Mode | Summer Mode On |
| Indoor Temp | 21 C |
| Outdoor Temp | 14 C |

Maintenance



Heat recovery units, by their very nature, require regular maintenance. The Sentinel Kinetic 200Z,200ZH,300Z,300ZH have been designed to facilitate access to enable maintenance to be carried out easily.





WARNING

THE FAN AND ANCILLARY CONTROL EQUIPMENT MUST BE ISOLATED FROM THE POWER SUPPLY DURING MAINTENANCE.

Filter Maintenance

| Item | Action |
|-------------|---------------------------------------------------------------------------------------------------------------------------------------------------------------------------------------------------------------------------------------------------------------------------------------------------------------------------------------------------------------------------------------------------------------------------------------------------------------------------------------------------------------------------------------------------------------------------------------------------------------------------------------------------------------------------------------------------------------------------------------------------------------------------------------------------------------------|
| Fan Filters | <p>When the unit displays “Check filters”. This is a reminder to ensure that the filters are not so dirty that they are blocking the airflow or allowing dirt to pass through. The rate at which the filters become dirty will vary depending on the environment and the activity within the property.</p> <ol style="list-style-type: none"> 1. Remove 2 filter cover plates and filters. 2. Clean gently by tapping or carefully using a vacuum cleaner if necessary. 3. Replace the filters and cover plates 4. Reset the automatic message, press and hold the  and  buttons for 5 seconds. |

12 Monthly Maintenance

| Item | Action |
|-----------------------------------------------|-------------------------------------------------------------------------------------------------------------------------------------------------------------------------------------------------------------------------------------------------------------------------------------------------------------------------------------------------------------------------------------------------------------------------------------------------------------------------------------------------------------------------------------------------------------------------------------|
| Fan Filters (Interval to suit environment) | <p>Change the Fan Filters depending on which environment the unit has been installed; urban, suburban or rural.</p> <ol style="list-style-type: none"> 1. Remove 2 filter cover plates and filters. 2. Insert the replacement filters. 3. Replace the filters and cover plates. 4. Reset the automatic message, press and hold the  and  buttons for 5 seconds. |
| Unit & Heat Exchanger Cell | Inspecting and cleaning the unit: See the following pages |
| Motors | Inspect the motors for build-up of dust and dirt on the impeller blades, which could cause imbalance and increased noise levels. Vacuum or clean if necessary. |
| Condensate Drain | Check the condensate drain tube is secure and clear of debris. Clean if necessary. |
| Fastenings | Check that all unit and wall-mount fastenings are sufficiently tight and have not become loose. Re-tighten if necessary. |

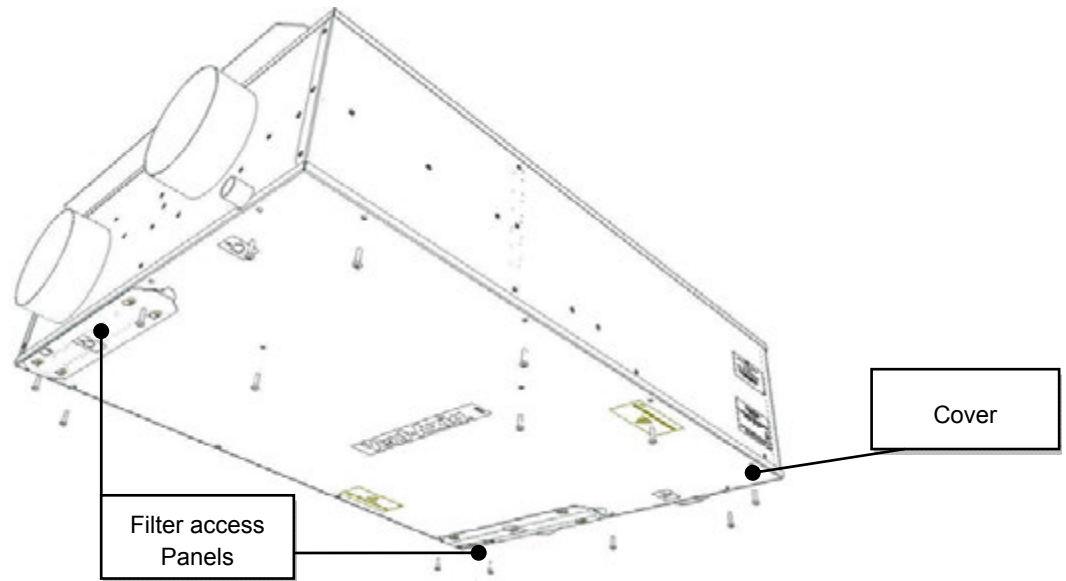

Stage 1: Isolate the mains power supply and remove the Filter access Panels and Filters.
Undo the securing screws and remove the Cover .

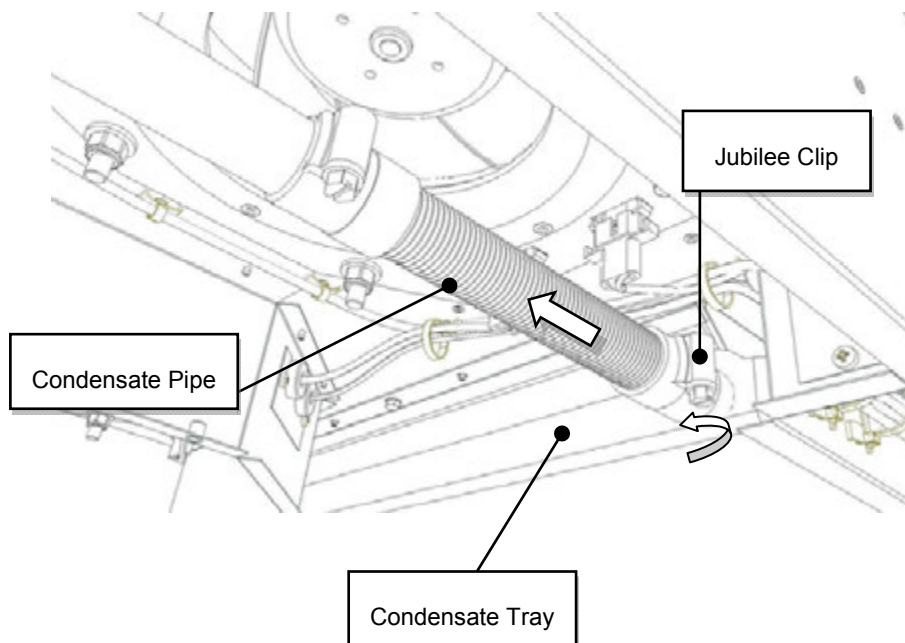

Stage 2: Loosen the Condensate Pipe Jubilee Clip and remove Pipe from Condensate Tray.

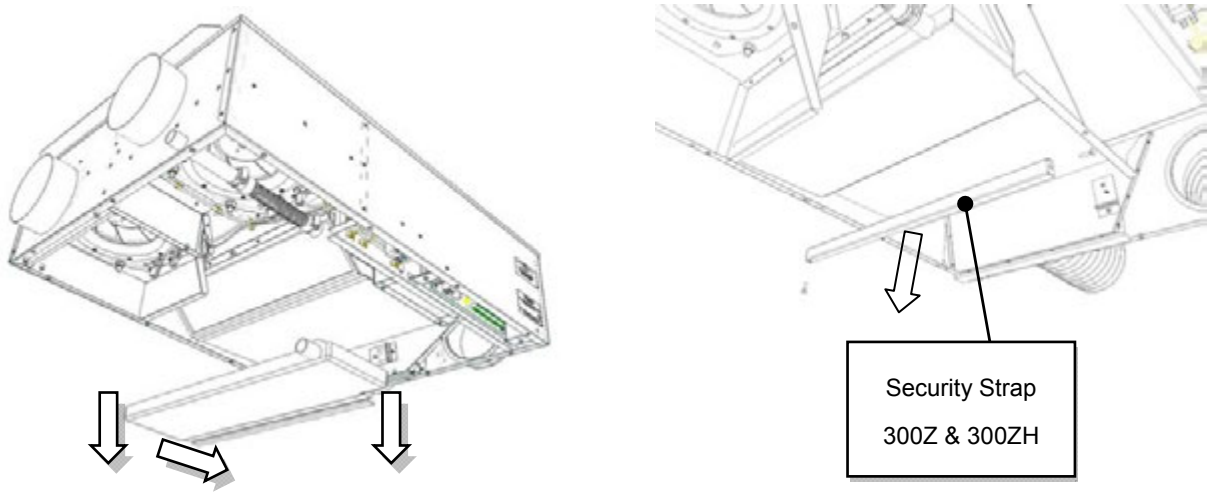

Stage 3: Remove the Condensate Tray.

Note: Remove the additional Security Strap on the 300Z & ZH before removing the Condensate Tray

Caution: Keep the Tray as horizontal as possible as this may contain condensate.

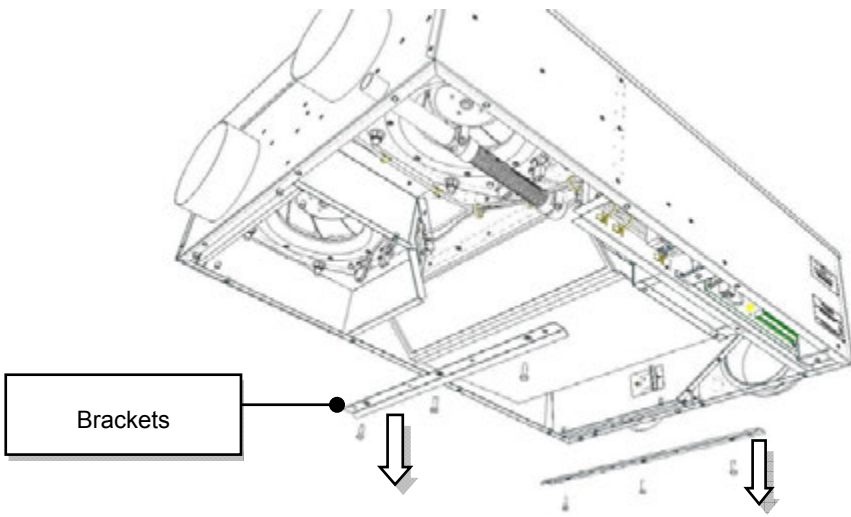

Stage 5: Remove the two Heat Exchanger fixing Brackets and Heat Recovery Cell.

Note : Take care when removing the Heat Recovery Cell.

Cleaning the Heat Exchanger Cell:

Wash the outer cover and heat exchanger in warm water using a mild detergent (such as Milton Fluid) and dry thoroughly.

Reassembly after maintenance:

For reassembly, please reverse this process ensuring the **Heat Exchanger Cell** is re-positioned with the “TOP” label visible and that the same level of care and attention is retained in re-applying all fixings to their previous locations.

Spares

The following spares can be ordered from Vent-Axia:

| Description | Part No 200Z & 200ZH | Part No 300Z &300ZH |
|----------------------------------------------------------------|----------------------|---------------------|
| Filters, 2 per pack | 449524 | 449575 |
| Heat Recovery Cell | 449525 | 449576 |
| Motor assembly | 449526 | 449526 |
| Control PCB | 449527 | 449527 |
| Temperature sensor kit (consists of a T1 & T2 sensor) | 449528 | 449577 |
| Wired remote controller (complete with 15 metre control cable) | 443283 | 443283 |

Troubleshooting

Diagnosing a Problem

In the event of a problem, always troubleshoot the unit according to:

- **Fault code** displayed on the Control Unit.
- **Fault LED** if connected.

If no indications are displayed, then troubleshoot problem according to the fault symptom as described in the following tables.

Service/Fault Code Screens

The Service screen is displayed, alternating with the Fault Code screen, when a fault has caused the unit to switch off and you must phone the telephone number displayed on the screen for assistance.

Service Phone
01293nnnnnn

The Fault Code screen is displayed, alternating with the Service screen, when a fault has occurred. Take note of the fault code when reporting a fault.

Fault Code
01

For assistance contact the service provider and quote the fault code number. The following fault codes numbers may be displayed. Code numbers are added together if more than one is detected.

| Code | Problem |
|------|----------------------------------------|
| 01 | Supply Fan not running |
| 02 | Extract Fan not running |
| 04 | PCB 24 V fuse (FS1) failure |
| 08 | Temperature sensor T1 (supply) faulty |
| 16 | Temperature sensor T2 (extract) faulty |
| 32 | Wired Remote Control failure |

Heating Failure Screen

Table 4: Fault Codes

The Room Too Cold screen displays the status of the fan. If the heating system in the building fails or is switched off and the internal temperature drops below 5°C, the unit will stop running so as to not bring cold air into an already cold house. The unit will start up every hour and will run for a short time to measure the temperature of the property. When the temperature rises, e.g. the heating system is switched back on, the unit will restart and continue normal operation.

Bottom line of display may be (**Fan Off, Fan Restarting**).

Note: Access to the commissioning screens is prevented if the display shows **Antifrost Active, Room Too Cold** or a **Fault Code**. In this event, switch the unit off and on again and enter the commissioning screens within one minute. If you are within the commissioning screens the Antifrost and Room Too Cold Failures modes will not operate allowing the flow rates to be adjusted even in a property which is below 5C.

Room Too Cold
Fan off

Appendix: Options and Accessories

CO₂ Sensor

An optional wall-mounted CO₂ Sensor (433257) may be used to control airflow. The CO₂ sensor measures the CO₂ level in ppm (parts per million) and the unit adjusts the fan speed accordingly. When the CO₂ level is below the lower threshold (adjustable), the fan will run at Normal speed. When the CO₂ level is above the upper threshold (also adjustable), the fan will run at Boost speed. If the CO₂ level is between the lower and upper thresholds, the fan will run at a speed between Normal and Boost proportional to the difference between the CO₂ level and the thresholds.

Normal / Boost Switch

An optional Normal/Boost Switch (455213) may be used to control airflow. Connecting a switch will enable a manual control to be used in conjunction with other boost controls.

Humidistats

An internal Relative Humidity Sensor PCB (441838) may be used to control airflow. The unit adjusts the fan speed proportionally depending on the temperature and relative humidity levels in the extracted air whilst avoiding nuisance tripping at night time when temperatures drop and relative humidity naturally rises. The unit does not just look for relative humidity levels above a set point, which can be unreliable in products that extract from multiple rooms, but it also looks for rapid increase in relative humidity typically generated by such activities as showering or cooking.

Connecting an opto-coupler (447340)

The LED terminals are intended to drive a remote LED to indicate that a fault has occurred. They provide a 5 V LED driving signal output between the + and – terminals that enables remote indication of a unit fault. See the Control Panel for fault code (Refer to installation and commissioning guide listed above). This signal could also be used by a BMS system so that it is informed that a fault has occurred. If a volt-free contact is required then use this opto-coupler to provide electrical separation.

Connect the flying leads of the opto-coupler pcb into the LED terminals, + to + and - to -
Connect the pair of leads from the BMS to the terminal block of the opto-coupler pcb. Polarity does not matter here.



BPC Ventilation Ltd
8 Redlands Road
Larne
BT40 1AX

T: 028 2827 5150

E: info@bpcventilation.com

W: www.bpcventilation.com